

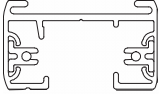

INSTALLATION INSTRUCTIONS



GES 204 (4ft)

GES 206 (6ft)

GES 208 (8ft)
mount

GES 212 (12ft)

one-circuit track, surface

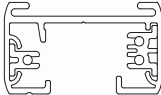
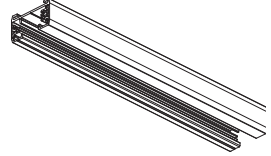

GET 304 (4ft)

GET 308 (8ft)
mount

GET 312 (12ft)

two-circuit track, surface

IMPORTANT SAFETY INSTRUCTIONS

Read All Instructions Before Installation

1. The GLOBAL trac *eco* system is intended for use with GLOBAL trac *eco* components and fixtures marked for use with the GLOBAL trac *eco* system. To reduce the risk of fire and electric shock, do not use other components as part of this system.
2. Track installation is only to be performed by a certified electrician in accordance with the National Electrical Code and all local codes and ordinances.
3. Single-circuit system: The *eco* GES track system is designed to be supplied by a single 120 volt branch circuit with a maximum capacity of 20 amps.
Two-circuit system: The *eco* GET track system is designed to be supplied by a balanced 120/240 volt, three-wire branch circuit with a maximum capacity of 40 amps.
4. Do not use this track system with a power supply cord or convenience receptacle adapter.
5. Do not install any fixtures closer than six inches from combustible materials.
6. Do not install the track in damp or wet locations.
7. Do not install the track with electric power connected. Similarly, disconnect electricity when installing or removing fixtures or components or changing the configuration of the track.
8. Do not attach anything other than UL listed lighting fixtures marked *for use with Nordic Aluminium GLOBAL trac eco system only* to the track.

IMPORTANT

**SAVE THESE INSTRUCTIONS FOR FUTURE REFERENCE WHEN
 ADDING FIXTURES OR CHANGING THE TRACK
 CONFIGURATION**

Mounting the Track

STEP 1

- 1.1) Locate the polarity line on the face of the track.
- 1.2) Insert feed connector into end(s) of track, matching polarity lines on connector and track (see Figure 1 below)
- 1.3) Tighten the locking screw(s) on each leg of the connector until secure (CAUTION: do not over tighten, as damage to the connector may result.)
- 1.4) Insert GES 41 dead end(s) into all open end(s) of track. Tighten the locking screw on each feed until secure.

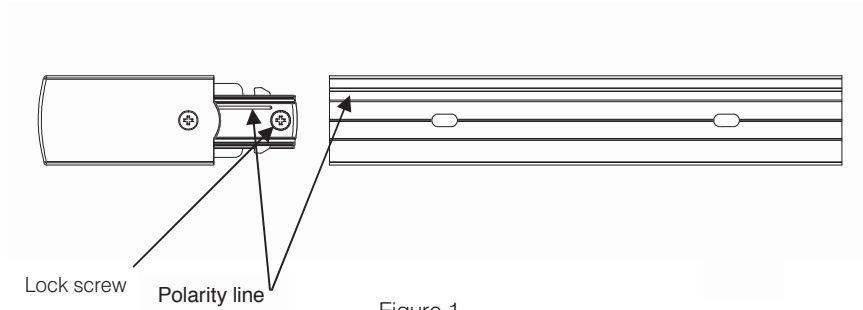

STEP 2

- 2.1) Locate the pre-drilled mounting holes in the back of the track.
- 2.2) Use toggle bolts or mounting screws to properly secure the track to the ceiling in the correct location. If mounting clips are required, these must be ordered separately.
- 2.3) Take care to ensure that the track is securely fastened to the ceiling at least once every four feet of length of the track.

STEP 3

- 3.1) Identify the feed connector that is to be used to provide power to the track.
- 3.2) Follow the installation instructions included with the appropriate feed connector.
- 3.3) The track must be wired and installed in accordance with the National Electrical Code and all applicable local codes and ordinances, by a qualified electrician.

STEP 4

Install the lighting fixtures in the track in accordance with the fixture manufacturer's instructions, taking care to match the polarity line of the track with the polarity line on the fixture adapter.

Cutting the track to length

GLOBAL *eco* track may be field-cut to length, using the following procedure:

1. Measure the desired length of track.
2. Using a hacksaw or other saw suitable for cutting aluminum, cut the track at with a clean perpendicular cut, ensuring that no damage to conductors results.
3. Remove all loose cutting debris and burrs from ends and inside of track.
4. Install appropriate feed connector or dead end.
5. If cutting the track eliminated a section with a mounting hole, it may be necessary to drill an additional mounting hole to ensure secure fastening to ceiling. If so, please consult the Field Drilling Instructions below.
6. Mount the track following instructions on the opposite page.

Field Drilling Instructions

GLOBAL *eco* track is supplied with pre-drilled mounting holes (see Figure 2 below.) It may be necessary to drill additional mounting holes in the field if:

- The track has been field-cut to length, using the procedure detailed above, or
- The provided mounting holes do not line up with the mounting surface above the track.

To drill additional mounting holes, use the following procedure:

1. On the inside of the track, mark the correct location for the mounting hole. Note that the track must be securely mounted at intervals no greater than four feet in length.
2. To ensure that the mounting hole does not interfere with a feed connector installed in the end of the track, ensure that the mounting hole is located no closer than 3 inches from the end of the track.
3. Using the drill guide running along the centerline of the inside of the track, drill a 3/16 inch hole through the track.
4. Remove all loose cutting debris and burrs from inside and outside of track.
5. Install appropriate feed connector or dead end.
6. Mount the track following instructions on the opposite page.

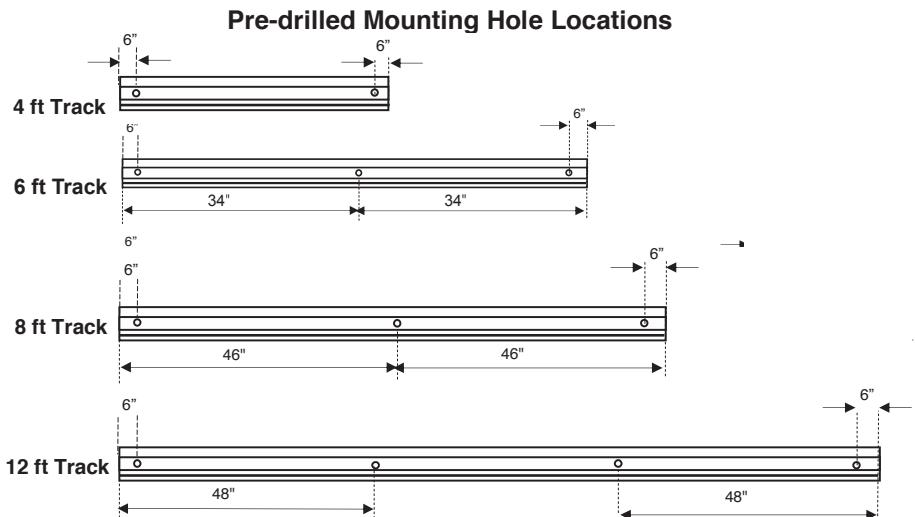
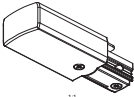
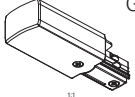
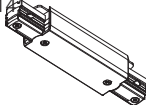
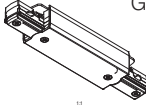
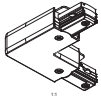
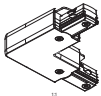
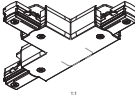
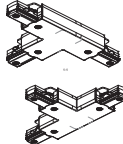
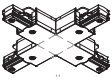
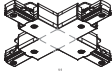

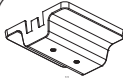
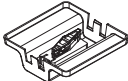

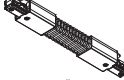
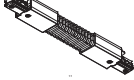



Figure 2

GLOBAL **eco** Feed and Connector Components

The GLOBAL trac **eco** system includes the following feed and connector components:

GES single-circuit system		GET two-circuit system
GES 11 	<p style="text-align: center;">Live end feeds</p> <p>For feeding power to surface mounted track from the end. Typically used in conjunction with a GES 15 Feed Canopy Cover.</p>	GET 11 
GES 14 	<p style="text-align: center;">Straight feed connectors</p> <p>For feeding power to surface mounted track in the middle of two runs. Typically used in conjunction with a GES 15 Feed Canopy Cover.</p>	GET 14 
GES 34 	<p style="text-align: center;">Adjustable L-connectors</p> <p>For connecting two lengths of track in an L-shape. Can be field adjusted to branch left or right. Can also be used as a feed connector.</p>	GET 34 
GES 40 	<p style="text-align: center;">T-connectors</p> <p>For connecting three tracks in a T-shape. The GES 40 can be field adjusted to be an inside or outside, left or right Tee. In the case of two-circuit, the GET 39 or GET 40 must be selected for left or right Tee connection. Can also be used as a feed connector.</p>	GET 39 GET 40 
GES 38 	<p style="text-align: center;">X-connectors</p> <p>For connecting four lengths of track in an X-shape. Can also be used as a feed connector.</p>	GET 38 
GES 21 	<p style="text-align: center;">Linear coupler</p> <p>For connecting two lengths of track in a linear configuration.</p>	GET 21 
GES 67 	<p style="text-align: center;">Floating Feed</p> <p>For feeding power to surface mounted track at any point along the length of the track.</p>	GET 67 
GES 13 	<p style="text-align: center;">Surface conduit feed</p> <p>For feeding track at the end with horizontal conduit run. Compatible with 1/2 inch conduit fitting.</p>	GET 13 
GES 23 	<p style="text-align: center;">Flexible connector</p> <p>For connecting two lengths of track at any angle, providing the ability to also connect two tracks at unequal elevation or in two different planes.</p>	GET 23 
GES 41 	<p style="text-align: center;">Dead end cover</p> <p>For all open ends of track</p>	GET 41 

Nordic Aluminium, Inc. 1075 Old Norcross Road, Suite A, Lawrenceville, GA 30045, USA
 Ph: 678-407-7876, Fax: 678-407-7875

